

MP1758A
Pulse Pattern Generator
Operation Manual
(Panel Operation)

Eleventh Edition

Read this manual before using the equipment.
Keep this manual with the equipment.

OCT.
2006

ANRITSU CORPORATION

Document No.: M-W0926AE-11.0

Safety Symbols

To prevent the risk of personal injury or loss related to equipment malfunction, Anritsu Corporation uses the following safety symbols to indicate safety-related information. Insure that you clearly understand the meanings of the symbols **BEFORE** using the equipment.

Symbols used in manual

- DANGER** This indicates a very dangerous procedure that could result in serious injury or death if not performed properly.
- WARNING** This indicates a hazardous procedure that could result in serious injury or death if not performed properly.
- CAUTION** This indicates a hazardous procedure or danger that could result in light-to-severe injury, or loss related to equipment malfunction, if proper precautions are not taken.

Safety Symbols Used on Equipment and in Manual

(Some or all of the following five symbols may not be used on all Anritsu equipment. In addition, there may be other labels attached to products which are not shown in the diagrams in this manual.) The following safety symbols are used inside or on the equipment near operation locations to provide information about safety items and operation precautions. Insure that you clearly understand the meanings of the symbols and take the necessary precautions **BEFORE** using the equipment.



This indicates a prohibited operation. The prohibited operation is indicated symbolically in or near the barred circle.



This indicates an obligatory safety precaution. The obligatory operation is indicated symbolically in or near the circle.



This indicates warning or caution. The contents are indicated symbolically in or near the triangle.



This indicates a note. The contents are described in the box.

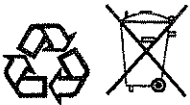

These indicate that the marked part should be recycled.

MP1758A Pulse Pattern Generator Operation Manual (Panel Operation)

May 1995 (First Edition)
August 2002 (Eleventh Edition)

Copyright © 1995 – 2002 by Anritsu Corporation

All rights reserved. No part of this manual may be reproduced without the prior written permission of Anritsu Corporation.

The contents of this manual may be changed without prior notice.

Printed in Japan

For Safety

WARNING



or



Repair

WARNING

Falling Over

1. Always refer to the operation manual when working near locations at which the alert mark shown on the left is attached. If the operation, etc., is performed without heeding the advice in the operation manual, there is a risk of personal injury. In addition, the equipment performance may be reduced.

Moreover, this alert mark is sometimes used with other marks and descriptions indicating other dangers.

2. This equipment cannot be repaired by the user. DO NOT attempt to open the cabinet or to disassemble internal parts. Only Anritsu-trained service personnel or staff from your sales representative with a knowledge of electrical fire and shock hazards should service this equipment. There are high-voltage parts in this equipment presenting a risk of severe injury or fatal electric shock to untrained personnel. In addition, there is a risk of damage to precision parts.
3. This equipment should be used in the correct position. If the cabinet is turned on its side, etc., it will be unstable and may be damaged if it falls over as a result of receiving a slight mechanical shock.

For Safety

CAUTION

Changing Fuse

CAUTION 

1. Before changing the fuses, ALWAYS remove the power cord from the poweroutlet and replace the blown fuses. Always use new fuses of the type and rating specified on the fuse marking on the rear panel of the cabinet.

T □ □ □ A indicates a time-lag fuse.

□ □ □ A or F □ □ □ A indicate a normal fusing type fuse.

There is risk of receiving a fatal electric shock if the fuses are replaced with the power cord connected.

Cleaning

2. Keep the power supply and cooling fan free of dust.
 - Clean the power inlet regularly. If dust accumulates around the power pins, there is a risk of fire.
 - Keep the cooling fan clean so that the ventilation holes are not obstructed. If the ventilation is obstructed, the cabinet may overheat and catch fire.
3. Use two or more people to lift and move this equipment, or use a trolley. There is a risk of back injury, if this equipment is lifted by one person.

 CAUTION/注意

>18kg

HEAVY WEIGHT/重量物

Equipment Certificate

Anritsu Corporation certifies that this equipment was tested before shipment using calibrated measuring instruments with direct traceability to public testing organizations recognized by national research laboratories including the Electrotechnical Laboratory, the National Research Laboratory of Metrology and the Communications Research Laboratory, and was found to meet the published specifications.

Anritsu Warranty

Anritsu Corporation will repair this equipment free-of-charge if a malfunction occurs within 1 year after shipment due to a manufacturing fault, provided that this warranty is rendered void under any or all of the following conditions.

- The fault is outside the scope of the warranty conditions described in the operation manual.
- The fault is due to misoperation, misuse, or unauthorized modification or repair of the equipment by the customer.
- The fault is due to severe usage clearly exceeding normal usage.
- The fault is due to improper or insufficient maintenance by the customer.
- The fault is due to natural disaster including fire, flooding and earthquake, etc.
- The fault is due to use of non-specified peripheral equipment, peripheral parts, consumables, etc.
- The fault is due to use of a non-specified power supply or in a non-specified installation location.

In addition, this warranty is valid only for the original equipment purchaser. It is not transferable if the equipment is resold.

Anritsu Corporation will not accept liability for equipment faults due to unforeseen and unusual circumstances, nor for faults due to mishandling by the customer.

Anritsu Corporation Contact

If this equipment develops a fault, contact Anritsu Corporation or its representatives at the address in this manual.

Corporate names and product names are the registered trademarks of their respective corporates.

MEMORY BACK-UP BATTERY REPLACEMENT

The power for memory back-up is supplied by a Poly-carbomonofluoride Lithium Battery. This battery should only be replaced by a battery of the same type; since replacement can only be made by Anritsu, contact the nearest Anritsu representative when replacement is required.

At the end of it's life, the battery should be recycled or disposed properly.

STORAGE MEDIUM

This equipment stores data and programs using Floppy Disk (FD) and backed-up memories. Data and programs may be lost due to improper use or failure. ANRITSU therefore recommends that you back-up the memory.

ANRITSU CANNOT COMPENSATE FOR ANY MEMORY LOSS.

Please pay careful attention to the following points. Do not remove the FD and backed-up memory from equipment being accessed. (Para. 4.8 (14))

(FD)

- Observe the specified environmental conditions. Also, do not use the equipment in a dusty place.
- Keep magnetic objects away from the disk. Do not bend the disk.

(Backed-up memory)

- Isolate the memory from static electricity.

Note: The battery life is about 10 years. Early battery replacement is recommended.

DISPOSING OF THE PRODUCT

The MP1758A uses chemical compound semiconductor including arsenic.

At the end of it's life, the MP1758A should be recycled or disposed properly.

CE Marking

Anritsu affixes the CE Conformity Marking on the following product (s) in accordance with the Council Directive 93/68/EEC to indicate that they conform with the EMC directive of the European Union (EU).

CE Conformity Marking



1. Product Name/Model Name

Product Name: Pulse Pattern Generator

Model Name: MP1758A

2. Applied Directive

EMC: Council Directive 89/336/EEC

LVD: Council Directive 73/23/EEC

3. Applied Standards

EMC:

Emission: EN61326: 1997/A1: 1998 (Class A)

Immunity: EN61326: 1997/A1: 1998 (Annex A)

	Performance Criteria*
IEC61000-4-2 (ESD)	B
IEC61000-4-3 (EMF)	A
IEC61000-4-4 (Burst)	B
IEC61000-4-5 (Surge)	B
IEC61000-4-6 (CRF)	A
IEC61000-4-8 (RPFMF)	A
IEC61000-4-11 (V dip/short)	B

*: Performance Criteria

A: During testing normal performance within the specification limits.

B: During testing, temporary degradation, or loss of function or which is self-recovering.

Harmonic current emissions:

EN61000-3-2: 1995/A2: 1998 (Class A equipment)

LVD: EN61010-1: 1993/A2: 1995 (Installation Category II ,
Pollution Degree 2)

Power Line Fuse Protection

For safety, Anritsu products have either one or two fuses in the AC power lines as requested by the customer when ordering.

Single fuse: A fuse is inserted in one of the AC power lines.

Double fuse: A fuse is inserted in each of the AC power lines.

Example 1: An example of the single fuse is shown below:

Fuse Holder

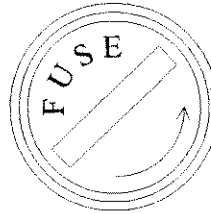

Example 2: An example of the double fuse is shown below:

Fuse Holders

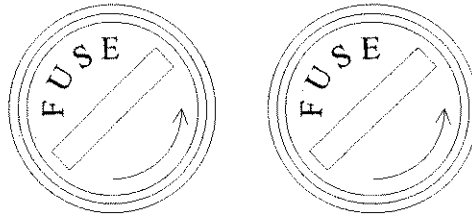

ABOUT THIS MANUAL

The MP1758A operation manuals are made up of the following two manuals. Use the manuals matching the usage objective.

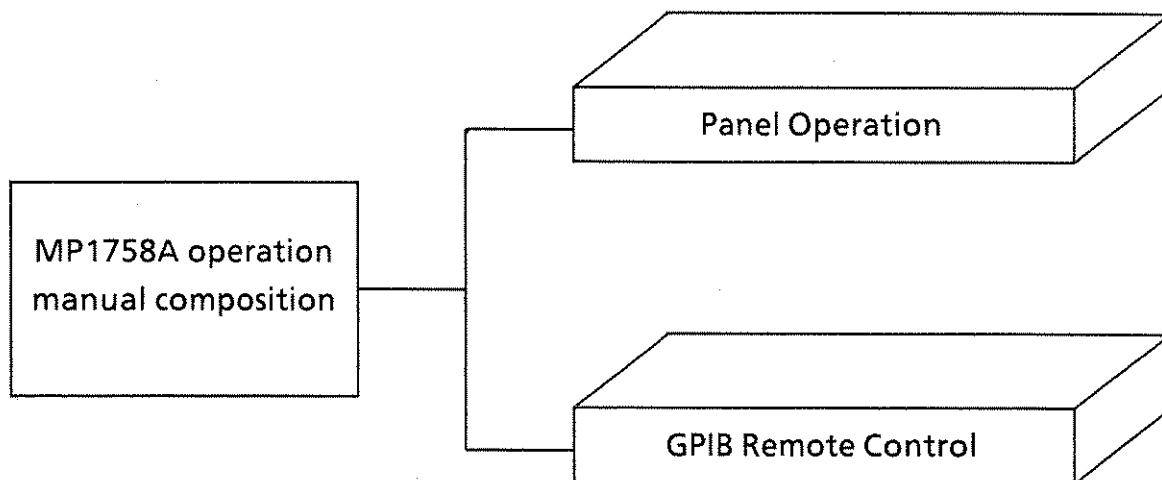

Panel Operation:

Outlines the MP1758A and describes its specifications, preparations, panels, manual (local) operation method, storage, transportation, function keys transition diagram, initial values table, and error messages.

GPIB Remote Control:

Since the MP1758A is compatible with IEEE488.2, this manual describes GPIB remote control based on IEEE488.2. The descriptions in this manual are based on N₈₈-BASIC programs using an NEC PC9800 Series personal computer for program generation reference.

(Blank)

TABLE OF CONTENTS

For Safety	iii
ABOUT THIS MANUAL	I
SECTION 1 GENERAL	1-1
1.1 General	1-1
1.2 Manual Composition	1-1
1.3 Composition	1-2
1.4 Optional Accessories and Peripheral Devices	1-3
1.5 Options	1-3
1.6 Specifications	1-4
1.6.1 Operation frequency range	1-4
1.6.2 External clock	1-4
1.6.3 Internal clock	1-4
1.6.4 Pattern generation	1-5
1.6.5 DATA output	1-7
1.6.6 CLOCK output	1-8
1.6.7 Output Phase	1-9
1.6.8 Sync signal output	1-10
1.6.9 Parameter memory	1-10
1.6.10 External unit control	1-10
1.6.11 External control	1-10
1.6.12 Options	1-11
1.6.13 Power supply	1-11
1.6.14 Dimensions and mass	1-11
1.6.15 Operating temperature range	1-11
1.6.16 Waste disposal measures	1-12
SECTION 2 PREPARATIONS	2-1
2.1 Installation Conditions	2-1
2.2 Safety Measures	2-2
2.3 Power Supply Voltage	2-3
2.4 Internal Battery Life	2-4
2.5 Damage Prevention Measures	2-5
2.6 Warm-up	2-6
SECTION 3 FRONT AND REAR PANELS	3-1
3.1 Panel Controls	3-1

SECTION 4	OPERATION	4-1
4.1	Frequency Setting of the Built-in Clock Generator	4-1
4.2	Reference Signal of the Built-in Clock Generator	4-2
4.3	Programmable Pattern Setting	4-3
4.4	Pseudorandom Pattern Setting	4-5
4.5	Logical Inversion	4-6
4.6	Error Addition	4-7
4.7	Output Amplitude, Offset Voltage, and Delay Setting	4-9
4.8	Memory	4-14
4.9	Parameters Initialization	4-20
SECTION 5	PRINCIPLES OF OPERATION	5-1
5.1	Block Diagram	5-1
5.2	Internal Clock Generator (A1)	5-1
5.3	Programmable Pattern Generator (A8/A12)	5-1
5.4	Pseudorandom Pattern Generator (A10)	5-1
5.5	Pattern Sync Output Period	5-6
	5.5.1 Pseudorandom pattern	5-6
	5.5.2 Programmable pattern	5-6
SECTION 6	MAINTENANCE	6-1
6.1	Regular Care and Preventive Maintenance	6-1
SECTION 7	CALIBRATION	7-1

SECTION 1

GENERAL

1.1 General

The MP1758A Pulse Pattern Generator is a pulse pattern generator with 4 CH data and 2 CH clock output capabilities. It can be operated on 100 MHz to 12.5 GHz clock frequencies.

This device can generate two types of patterns; the programmable pattern and the pseudorandom pattern. The programmable pattern has 1 CH, 2 CH and 4 CH modes, and can generate up to 512 k bit length pattern. The pseudorandom pattern can generate 7 types of patterns with periods ranging from $2^7 - 1$ to $2^{31} - 1$.

This device can be combined with the MUX unit. This combination can also generate both the programmable pattern and pseudorandom pattern.

For the output interface, the offset can be set in 5 mV steps, the amplitude can be set in 10 mV steps and the delay between output data signal and clock signal can be set in 1 ps steps.

The clock signal can be supplied from an external or an internal clock generator. The internal clock generator frequency can be set from 100 MHz to 12.5 GHz in 1 kHz steps.

1.2 Manual Composition

Two manuals are related to handling of the MP1758A Pulse Pattern Generator: this manual and the GPIB operation manual. When controlling the MP1758A remotely via a GPIB, refer to the GPIB operation manual.

1.3 Composition

The standard composition of the MP1758A Pulse Pattern Generator is shown in Table 1-1.

Table 1-1 Standard Composition

Item	No.	Name	Qty	Remarks
Instrument		MP1758A Pulse pattern generator	1	
Accessories supplied	F0071	Fuses	2	10 A
	J0491	Power cord	1	2.5 m, sheilded
	J0008	GPIB cable	1	2 m
	J0496	Adapter	7	APC 3.5-J · APC 3.5-J
	J0696A	Coaxial cable	6	SMA-P · SMA-P, 0.5 m
	J0696B	Coaxial cable	1	SMA-P · SMA-P, 0.8 m
	J0693	Coaxial cable	1	SMA-P · SMA-P, 1 m (for synchronous output)
	Z0168	3.5-inch floppy disk	2	2HD
	Z0306A	Wrist strap	1	
	W0926AE	Operation manual	1	
	W0927AE	GPIB operation manual	1	

1.4 Optional Accessories and Peripheral Devices

The MP1758A optional accessories and peripheral devices (sold separately) are shown in Table 1-2.

Table 1-2 Optional Accessories

Model No./ Order No.	Name	Remarks
J0696A	Coaxial cable	SMA-P · SMA-P, 0.5 m
J0696B	Coaxial cable	SMA-P · SMA-P, 0.8 m
J0693	Coaxial cable	SMA-P · SMA-P, 1.0 m (for synchronous output)
J0500A	Semirigid cable	SMA-P · SMA-P, 0.5 m
J0496	Adapter	APC 3.5-J · APC 3.5-J
Z0168	3.5-inch floppy disk	2HD
MB24B	Portable Test Rack	20 A with 20 A power cord/plug
J0007	GPIB cable	1 m
J0008	GPIB cable	2 m
F0079	Fuses	10 A (MF51NR10)
J0491	Power cord	2.5 m, sheilded
Z0306A	Wrist strap	

1.5 Options

The following options are available for the MP1758A.

OPTION01 CLOCK $\overline{\text{CLOCK}}$ output

OPTION02 Crosspoint adjustment

1.6 Specifications

1.6.1 Operation frequency range

(1) Internal clock

0.1 to 12.5 GHz

(2) External clock

0.1 to 12.5 GHz

1.6.2 External clock

(1) Input level

0.8 to 2.0 V_{p-p}

(2) Waveform

sinusoidal wave (≥ 500 MHz) or square wave

(3) Input impedance

50 Ω

(4) Connector

APC-3.5

1.6.3 Internal clock

(1) Resolution

1 kHz or 1 MHz

(2) Frequency accuracy

± 1 ppm

(3) Reference signal

10 MHz (Internal)

(4) SSB phase noise

At 10 kHz offset and 1 Hz band

≤ -85 dBc/Hz (0.1 to < 4.0 GHz)

≤ -80 dBc/Hz (4.0 to < 8.0 GHz)

≤ -75 dBc/Hz (8.0 to 12.5 GHz)

1.6.4 Pattern generation

(1) Pseudorandom binary sequence pattern (PRBS)

(a) Pattern length

$$2^N - 1 \quad N = 7, 9, 11, 15, 20, 23, 31$$

(2) Programmable pattern

(a) 1 CH mode

- CH setting 1
- Data length 4 to 524288 bits/4 outputs
(Values to be set are shown in Table 1-3)
- Pattern reset/preset All or page

(b) 2 CH mode

- CH setting 1 to 2
- Data length 2 to 262144 bits/2 outputs
(Values to be set are shown in Table 1-3)
- Pattern reset/preset All (each CH) or page

(c) 4 CH mode

- CH setting 1 to 4
- Data length 1 to 131072 bits/1 output
(Values to be set are shown in Table 1-3)
- Pattern reset/preset All (each CH) or page

Table 1-3 Programmable Pattern Setting Values

Mode	CH setting	Data length (N)/CH	Step
1 CH	1	4 to 524288b	4 (N ≤ 8 Kb) 8 (N ≤ 16 Kb) 16 (N ≤ 32 Kb) 32 (N ≤ 64 Kb) 64 (N ≤ 128 Kb) 128 (N ≤ 256 Kb) 256 (N ≤ 512 Kb)
2 CH	1 to 2	2 to 262144b	2 (N ≤ 4 Kb) 4 (N ≤ 8 Kb) 8 (N ≤ 16 Kb) 16 (N ≤ 32 Kb) 32 (N ≤ 64 Kb) 64 (N ≤ 128 Kb) 128 (N ≤ 256 Kb)
4 CH	1 to 4	1 to 131072b	1 (N ≤ 2 Kb) 2 (N ≤ 4 Kb) 4 (N ≤ 8 Kb) 8 (N ≤ 16 Kb) 16 (N ≤ 32 Kb) 32 (N ≤ 64 Kb) 64 (N ≤ 128 Kb)

(3) Logic inversion

The pseudorandom pattern and the programmable pattern allow logical inversion.

(4) Error insertion

(a) Error rate

10^{-n} : n = 4, 5, 6, 7, 8, 9 and single

(b) Insertion position

Possible to insert into any 1 CH of 32 CH (Selectable with rear panel switch, CH to be added to is as shown in Table 1-4).

Table 1-4 Error Addition CH

Specified CH on the rear switch	Error addition output
0, 1, 5, 9, 13, 17, 21, 25, 29	DATA1
2, 6, 10, 14, 18, 22, 26, 30	DATA2
3, 7, 11, 15, 19, 23, 27, 31	DATA3
4, 8, 12, 16, 20, 24, 28, 32, 33 to 99	DATA4

1.6.5 DATA output

(1) Waveform format

NRZ

(2) Number of outputs

4 (DATA1, DATA2, DATA3, DATA4)

(3) Amplitude

(a) Setting level

0.5 to 2.0 V_{p-p}

(b) Offset voltage

-2.0 to 2.0 V_{OH}

(c) Setting error

$\leq \pm 15\%$, ± 100 mV whichever is greater

(4) Rise/fall time

≤ 30 ps (20 % to 80 % value)

(5) Pattern jitter

≤ 25 ps

(6) Waveform distortion

$\leq 15\%$

(7) Load impedance

50 Ω , terminal voltage: 0 V/-2 V (ECL) selectable

(8) Connector

APC-3.5

1.6.6 CLOCK output

(1) Number of outputs

2 (CLOCK1, CLOCK2)

(2) Delay amount between clock output (CLOCK1, CLOCK2) and data output (DATA1, DATA2, DATA3, DATA4)

(a) Setting range

± 500 ps

(b) Setting resolution

1 ps

(3) Amplitude

(a) Setting level

0.5 to 2.0 V_{p-p}

(b) Offset voltage

-2.0 to 2.0 V_{OH}

(c) Setting error

$\leq \pm 15\%$, ± 100 mV whichever is greater

(4) Rise/fall time

≤ 30 ps (20 % to 80 % value)

(5) Waveform distortion

$\leq 15\%$

(6) Load impedance

50 Ω , terminal voltage: 0 V/-2 V (ECL) selectable

(7) Connector

APC-3.5

1.6.7 Output phase

Output phase is shown in Fig. 1-1

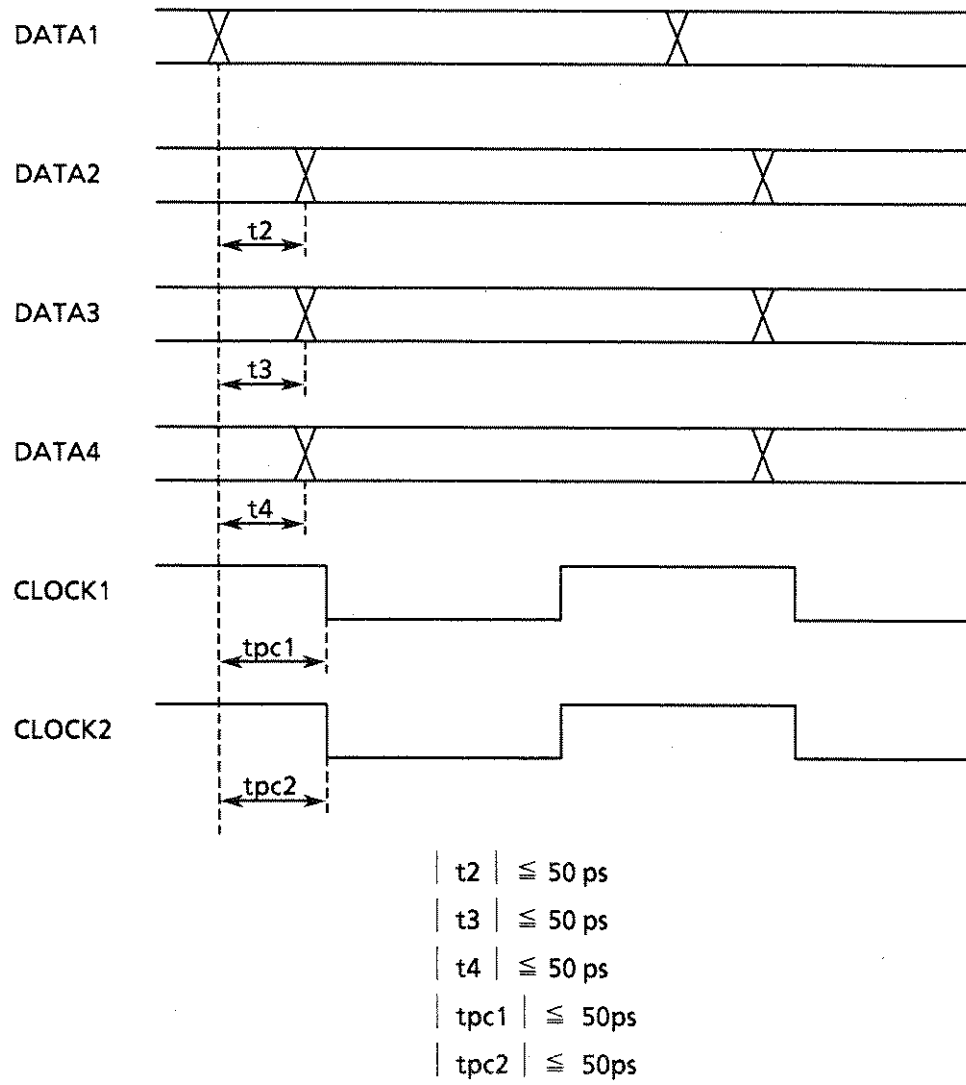

Fig. 1-1 Output Phase

1.6.8 Sync signal output

(1) Number of outputs

1 (1/32 clock output, pattern synchronous output selectable)

(2) Output level

1 V_{p-p} ± 20 % (VOH: 0 V ± 200 mV)

(3) Load impedance

50 Ω, terminal voltage: 0 V

(4) Connector

SMA

1.6.9 Parameter memory

(1) Media

3.5 inch floppy disk (2DD/2HD)

(2) Format

MS-DOS

(3) Content

Programmable pattern and other parameters

1.6.10 External unit control

A data amplitude can be set to the external MUX unit.

1.6.11 External control

GPIO (IEEE488.2 compatible)

1.6.12 Options

(1) OPTION01 $\overline{\text{CLOCK}}$ output

Clock outputs CLOCK1 and CLOCK2 are changed to CLOCK and $\overline{\text{CLOCK}}$. The output phase is shown in Fig. 1-2.

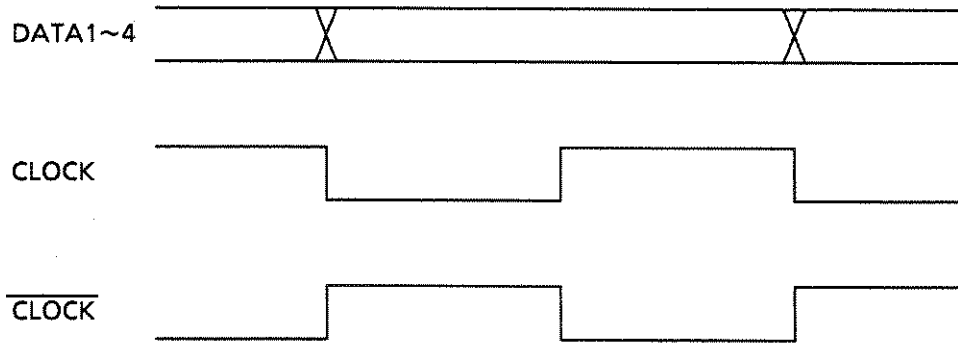

Fig. 1-2 OPTION01 Output Phase

(2) OPTION02 Crosspoint adjustment

The crosspoint of data output can be set by the lateral half-fixed volume.

1.6.13 Power supply

100 V system: 85 to 132 Vac, 200 V system: 170 to 250 Vac, max. 250 Vac, 47.5 to 63 Hz, ≤ 1000 VA

1.6.14 Dimensions and mass

221 H \times 426 W \times 450 D mm, ≤ 35 kg

1.6.15 Operating temperature range

15 to 35 °C

1.6.16 Waste disposal measures

This device contains certain hazardous substances defined by the Notification No.16 of the Environmental Agency of Japan. When disposing this device, pay attention and dispose of such substances complying with the ordinances of the country.

Part No.	Module name	Hazardous substance
A01	SYNTHESIZER	Galium arsenide
A05	CPU	Lithium
A09/A11	MUX	Galium arsenide
A13	CLOCK IN	Galium arsenide
A14	CLOCK DRIVER	Galium arsenide
A19	CLOCK OUT	Galium arsenide
A20	DATA OUT	Galium arsenide
A21	CLOCK BRANCH	Galium arsenide
A29	FREQ. DIVIDER	Galium arsenide
D2	MHL70430A	Galium arsenide

SECTION 2 PREPARATIONS

2.1 Installation Conditions

Operating temperature and humidity range	15°C to 35°C (However, 5°C to 40°C for floppy disks), Relative humidity \leq 95%
Storage temperature and humidity range	-40 to 70°C, Relative humidity \leq 95%

Use and store the MP1758A within these ranges.

Do not use or store the instrument in locations

- where vibrations are severe.
- where it is damp or dusty.
- where there is exposure to direct sunlight.
- where there is exposure to active gases.

Long-term storage at high temperature will increase the discharge rate of the internal battery. Store the instrument below room temperature.

2.2 Safety Measures

- Use the power cord (an accessory) to connect the instrument to the ac power supply.
Ground either the ground terminal of the power cord or the frame ground terminal on the rear panel.
- Turn off the POWER switch and disconnect the power cord from the socket before changing the fuse.
Use a fuse of the same rating.
- If the MP1758A is operated at room temperature after being used, or stored, for a long time at low temperature, condensation may occur and cause short-circuiting. To prevent this, do not turn the power on until the instrument is completely dry.

2.3 Power Supply Voltage

The power supply voltage rating for the MP1758A is shown on the rear panel. Always use a voltage within the rated voltage range. Excessive voltage may damage the circuits.

2.4 Internal Battery Life

The MP1758A uses lithium primary cells as the timer and memory back-up power supply. The life of the cells depends on the temperatures at which the instrument is stored. It is more than 10 years for storage at room temperature.

Storage at high temperature for long periods will shorten this period.

Replace discharge cells: they cannot be recharged.

Since battery replacement can only be made by Anritsu, contact the nearest Anritsu representative when replacement is required.

2.5 Damage Prevention Measures

- When applying signals to the MP1758A, never apply an excessive voltage because the circuits may be damaged.
- The output is terminated at 50 Ω . Do not feed current.
- Always ground the equipment to be connected (including the device under test) before connecting the input and output terminals. (For countermeasure to electro-static electricity)
- Since the outer shield and center conductors of a coaxial cable act as a capacitor, discharge the shield and center conductors by shorting them with a piece of metal.

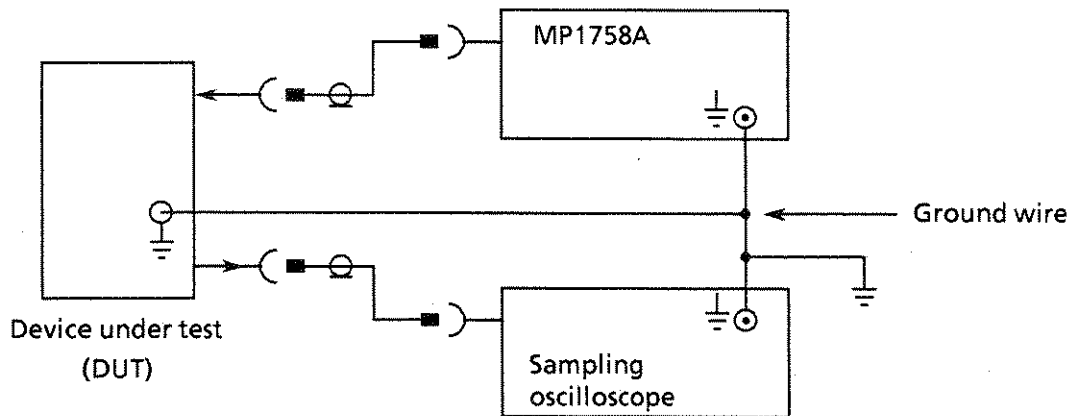
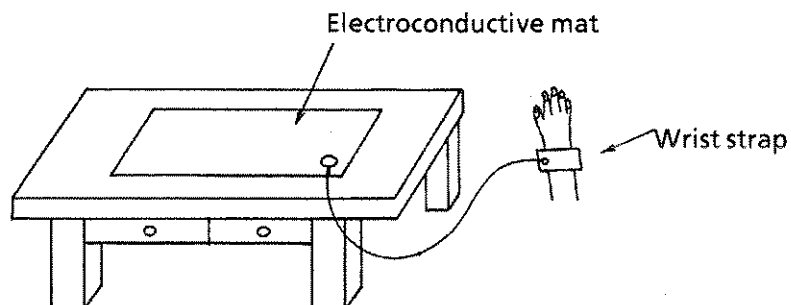

Fig. 2-1 Grounding and Cable Discharging

- The bottom section of the MP1758A includes hybrid ICs and important circuits and parts which are susceptible to static electricity. Do not open it.
- The hybrid ICs used in the MP1758A are air-tight. Do not open them. If they are opened and then do not perform satisfactorily, maintenance service may be refused.
- Ventilation holes exist at the bottom cover. Do not disturb the air flow through the holes.
- To protect the MP1758A from damage due to static electricity, place an electroconductive mat on the work bench and put on a wrist strap during work. Connect the other end of the wrist strap to the electroconductive mat or to the GND terminal of the MP1758A.



2.6 Warm-up

Make a warm-up run for 20 minutes or longer after the power is turned on.

SECTION 3 FRONT AND REAR PANELS

3.1 Panel Controls (Figs. 3-1, 3-2 and Table 3-1)

Table 3-1 Panel Control Explanation

No	Label	Function
①	POWER	Power switch and lamp
②	GPIB REMOTE LOCAL	GPIB local key and remote lamp Lamp that shows that the MP1758A is in the remote state Key for manual switching from the GPIB remote state to the local state
③	PANEL LOCK	Panel lock key and lamp In the panel lock state, all switches and keys other than the POWER switch and panel lock key are disabled
④	CLOCK INT/EXT EXT INPUT	Internal/external clock selector key and external clock input connector Internal/external clock selector key External clock input connector
⑤	SYNC OUTPUT 1/32 CLOCK/PATTERN SYNC OUTPUT	Sync signal output selector key and connector when waveform observed with an oscilloscope Sync signal selector key Sync signal output connector
⑥	PRESET ALL $\left[\begin{array}{l} 0 \\ 1 \end{array} \right.$ GUARD PAGE $\left[\begin{array}{l} 0 \\ 1 \end{array} \right.$	Programmable pattern preset function Sets all bits of CH to 0 Sets all bits of CH to 1 Guard key for the above Sets all bits of current page to 0 Sets all bits of current page to 1
⑦	PATTERN LOADING	Lamp indicating that a programmable pattern is being loaded

Table 3-1 Panel Control Explanation (Cont.)





No	Label	Function
⑧	BIT	Programmable pattern setting keys and display lamps
⑨	OUTPUT DATA1 DATA2 DATA3 DATA4 CLOCK1 CLOCK2	Output connectors Data output connector (Amplitude and offset can be varied) Clock output connector (Amplitude, offset, and delay can be varied)
⑩	GND/ECL ECL-GUARD	Clock output terminal selector display Clock output terminal selector key and guard key
⑪	CHANNEL	Clock output parameter setting knob and display selector key
⑫	AMPLITUDE 	Clock output amplitude setting knob and display
⑬	OFFSET 	Clock output offset voltage setting knob and display
⑭	DELAY TIME BUSY	Clock output delay setting knob and display Display lamp for delay setting
⑮	OFFSET 	Data output offset voltage setting knob and display
⑯	AMPLITUDE 	Data output amplitude setting knob and display
⑰	CHANNEL	Data output parameter setting knob and display selector key

Table 3-1 Panel Control Explanation (Cont.)





No	Label	Function
⑮	GND/ECL ECL-GUARD	Data output terminal selector display Data output terminal selector key and guard key
⑯	OFFSET	Offset reference value selector key
⑰	ERROR ADDITION (1×10^{-N})	Error addition selector keys and display lamp
⑱	 	Programmable-pattern mode, and pseudorandom-pattern period ($2^N - 1$) selector keys
⑳	LOGIC POS/NEG	Output logic positive/negative selector key and display lamp
㉑	PAGE	Page selector keys and display for a pattern to be set by pattern setting keys (㉓ BIT) in programmable pattern setting
㉒	DATA LENGTH	Data length setting keys and display in programmable pattern setting
㉓	DATA CHANNEL	Pattern channel selector key and display in programmable pattern setting
㉔	RESOLUTION MHz/kHz	Frequency setting resolution selector key
㉕	FREQUENCY	Internal clock frequency display
㉖	 	Frequency-change step selector keys
㉗	TUNING	Frequency-setting function ON/OFF key and display lamp
㉘		Frequency setting knob

Table 3-1 Panel Control Explanation (Cont.)





No	Label	Function
①	<p>MEMORY</p> <p>EXIST</p>    <p>DIR/FILE No</p> <p>RECALL/ DELETE</p> <p>SAVE/RESAVE</p> <p>SHIFT</p> <p>MODE PTN/OTHERS</p>	<p>Patterns and other set conditions memory</p> <p>Lamp which shows that a registered file exists</p> <p>File number and error code display</p> <p>File number setting keys</p> <p>Above file-number-setting-key function selector key and display lamp</p> <p>Memory contents recall or memory contents delete (shift mode) key and display lamp</p> <p>Save and resave (shift mode) to file key and display lamp</p> <p>Shift mode key and display lamp</p> <p>Selector key between pattern and other set condition memory functions, and display lamp</p>
②		Floppy disk drive
③	<p>STD 10 MHz</p> <p>BUFFER OUTPUT</p> <p>INPUT TTL</p> <p>OUTPUT TTL</p> <p>INT/EXT</p>	<p>Internal synthesizer reference-signal input/output</p> <p>Reference-signal buffered output connector</p> <p>Reference-signal input connector</p> <p>Reference-signal output connector</p> <p>Reference-signal oscillator internal/external selector switch</p>

Table 3-1 Panel Control Explanation (Cont.)

No.	Label	Function
⑳	GPIB	GPIB connector and address setting switches
㉑	FUNCTION	Function selector switches
㉒	ERROR ADDITION CH (1-32)	Error addition channel selector switches
㉓		U-link for internal synthesizer reference-signal OUTPUT/INPUT connector connection
㉔	REMOTE INTERFACE	External MUX unit control terminal
㉕	AC ** V, ***A	Power inlet
㉖		Frame ground terminal

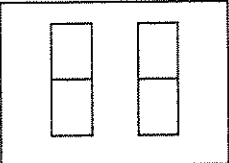
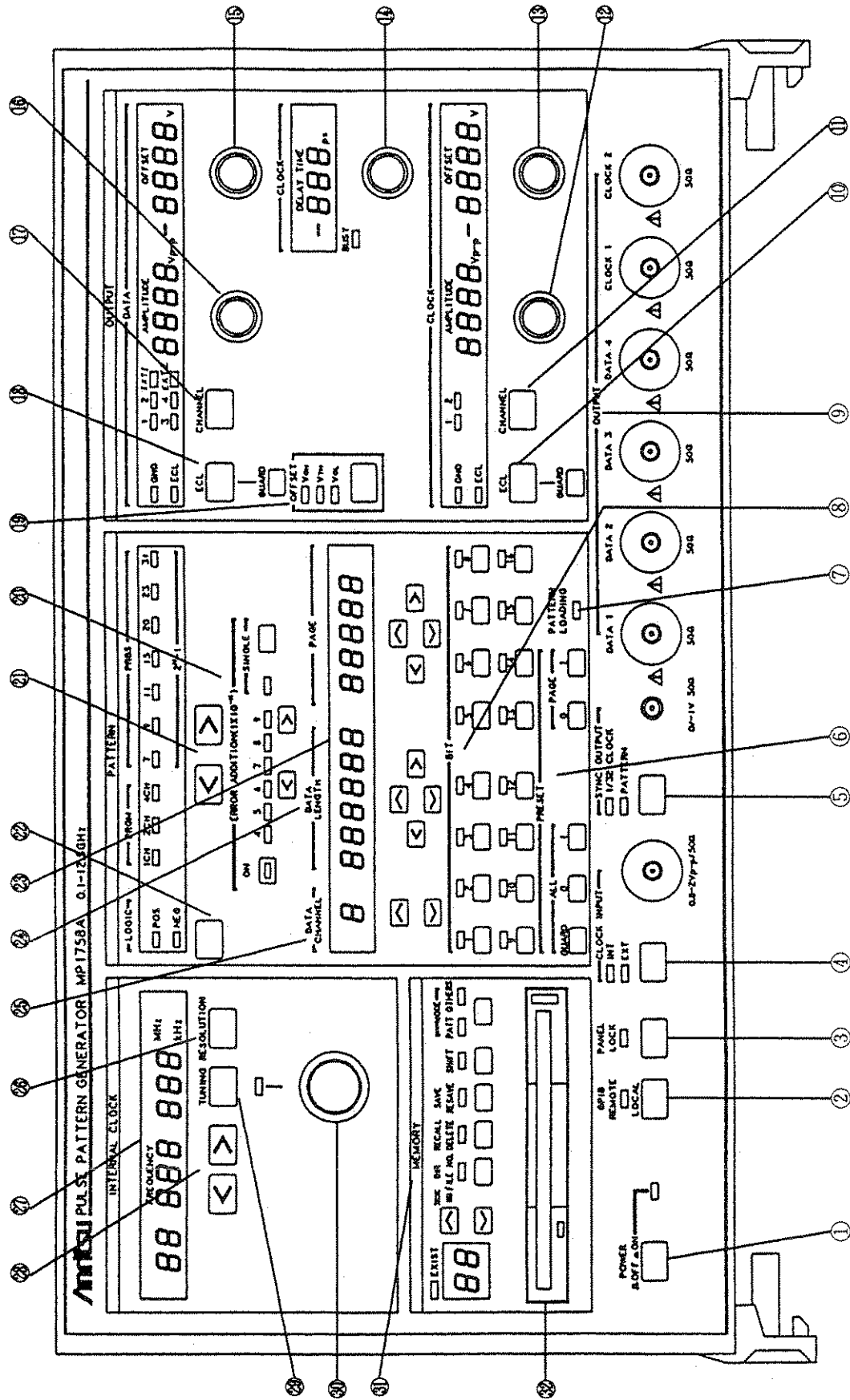

Fig. 3-1 Front Panel

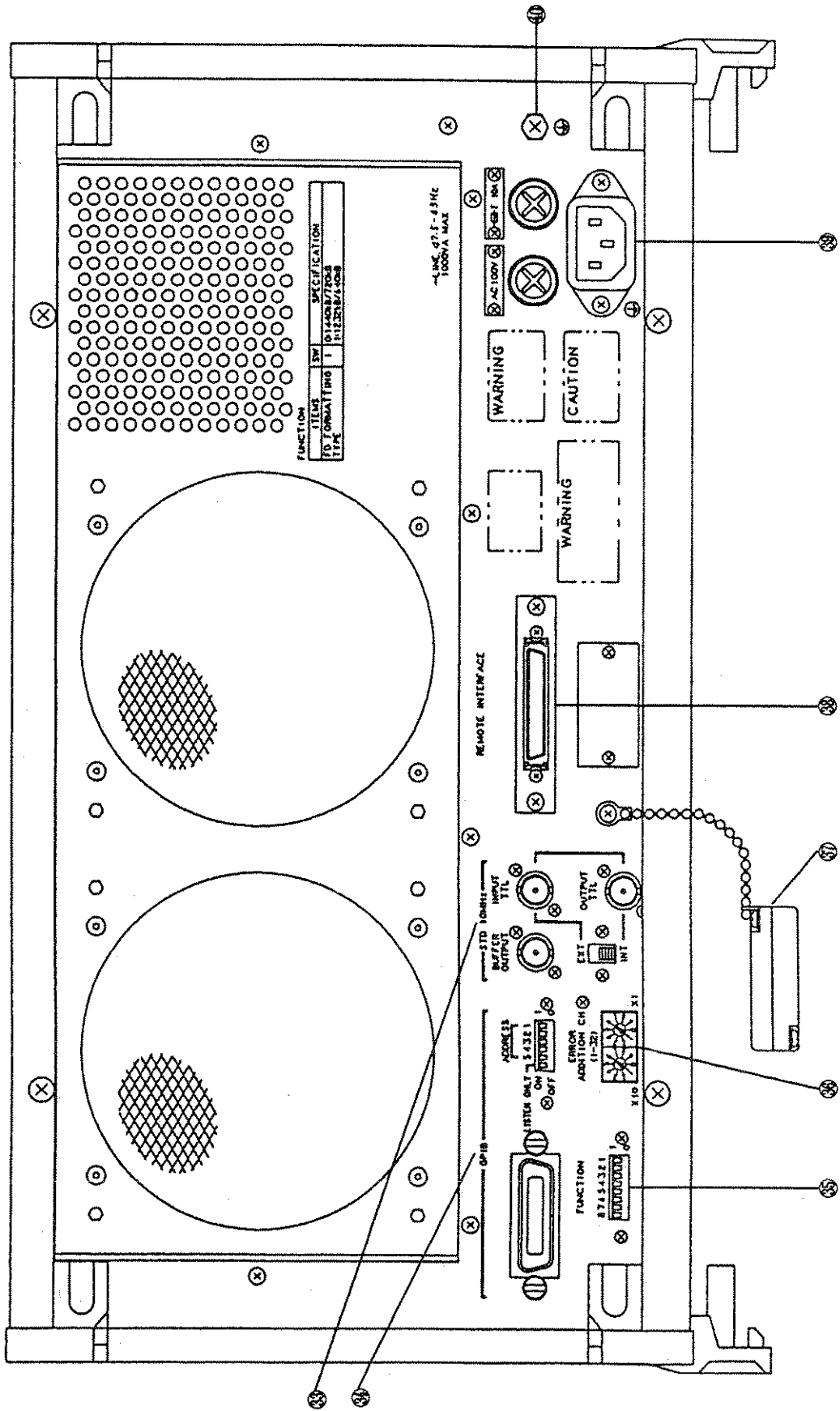

Fig. 3-2 Rear Panel

(Blank)

SECTION 4

OPERATION

This section describes methods of panel operation and connection.

4.1 Frequency Setting of the Built-in Clock Generator

(1) Frequency setting mode

Press the TUNING key ⑨ to enable frequency setting. (The display lamp is turned on.)

(2) Resolution setting

Set the frequency setting resolution to 1 kHz or 1 MHz by the resolution setting key ⑩.

Changing the setting resolution does not affect the frequency setting response time and C/N.

(3) Frequency-change step setting

Set the change step by the frequency change step keys [<] [>] ⑪. The flashing cursor indicating the changeable column position of the frequency display ⑫ is moved to the left by pressing [<], and to the right by pressing [>].

(4) Frequency setting

Turn the frequency setting knob ⑬ to set a frequency.

4.2 Reference Signal of the Built-in Clock Generator

(1) Operation using the built-in reference oscillator (Normally, use this mode)

Set the INT/EXT selector switch of STD 10 MHz ③ on the rear panel to INT, and connect the reference signal input connector (INPUT TTL) to the reference signal output connector (OUTPUT TTL) with the U-link ⑦.

(2) Operation by the external reference signal

Set the INT/EXT selector switch of STD 10 MHz ③ on the rear panel to EXT, and connect the external reference signal oscillator to the reference signal input connector (INPUT TTL).

The input level must be the TTL level.

4.3 Programmable Pattern Setting

(1) Pattern selection

Select an output pattern by [\leftarrow][\rightarrow] keys ⑳ so that the PRGM 1 CH/2 CH/4 CH display lamp turns on. Three modes of 1 CH, 2 CH and 4 CH can be used.

(2) Data length setting

In the programmable pattern, if the data length is N, the periodic pattern data having a period of N is generated.

The data length to be set varies depending on the mode. In the 1 CH mode, the data length can be 4 to 524288 bits. The data length value is set to be divisible by the step value.

The data length is set by the DATA LENGTH display and keys ㉔.

The flashing cursor indicating the changeable column position of the data length display is moved by pressing [\leftarrow][\rightarrow] keys. Set the number of changeable columns by [\vee][\wedge] keys.

(3) Channel setting

Specify the channel to be set in the programmable pattern.

The settable number is; 1 to 4 in the 4 CH mode and 1 or 2 in the 2 CH mode. In the 1 CH mode, fixed to 1.

Set the channel by the DATA CHANNEL display and keys ㉕.

Set the number of the changeable column by [\vee][\wedge] keys.

(4) Pattern setting

Set page "1" by the page keys ㉖.

Then, patterns of the data length N, from the first bit through the sixteenth bit, can be set by the BIT keys ㉗. In case N is less than 16, the remaining keys become ineffective and the lamp is always off.

In case N is larger than 16, change to "2" by the page keys ㉖, so that patterns can be set from the seventeenth bit through the thirty-second bit. It is also possible to set patterns for bits of larger than 32 in units of sixteen bits.

(5) Output pattern in case the data length is changed

If the data length is changed from P to Q, data from the first bit through the Q-th bit are repeatedly output. If $P > Q$, since the pattern data of the (Q+1)-th bit through the P-th bit remain stored in the internal memory, the original pattern is output by changing the data length back to P.

(6) Programmable pattern presetting

(a) Setting all bits "0"

Press the ALL0 key while pressing the GUARD key of the PRESET ⑥ to set all bits of the set channel to "0".

Here, the all bits refer to the setting of the currently output pattern and all of the buffer memory (128 k bits) connected to it.

(b) Setting all bits "1"

Press the ALL1 key while pressing the GUARD key of the PRESET ⑥ to set all bits of the set channel to "1".

(c) Setting "0" for one page

Press the PAGE 0 key of the PRESET ⑥ to set all the bits of the currently displayed page to "0". However, note that only the programmable bits are set to "0". (For example, in case the data length is 12, from the first bit through the twelfth bit are set to "0".)

(d) Setting "1" for one page

Press the PAGE 1 key of the PRESET ⑥ to set all the bits of the currently displayed page to "1". Only the programmable bits are set to "1".

Note: If the flashing cursor is moved further than the leftmost or the rightmost position by [<] [>] keys, it stops flashing and numeral setting becomes unavailable. To resume setting again, press the [<] or [>] key to flash a column you want to change.

4.4 Pseudorandom Pattern Setting

(1) Selection of pseudorandom pattern types

Select the type of pseudorandom (PRBS) pattern by [\leftarrow][\rightarrow] keys ①.

For the bit length of PRBS pattern period, 7 types ($2^7 - 1$ bits to $2^{31} - 1$ bits) can be selected. ($2^N - 1$: $N = 7, 9, 11, 15, 20, 23, 31$)

4.5 Logical Inversion

(1) Programmable pattern



When the BIT ⑧ display lamp is on, the state is called "1", and when it is off, the state is "0".

In case the positive logic is selected by turning on the POS display lamp by the LOGIC key ⑳, "1" is output corresponding to the high-level and "0" to the low-level. In case the NEG display lamp is turned on and the negative logic is selected, "1" is output corresponding to the low-level and "0" to the high-level.

(2) Pseudorandom pattern

In the pseudorandom pattern, when the positive logic is selected, "1" is output corresponding to the low-level and "0" to the high-level. When the negative logic is selected, the operation is reversed.

4.6 Error Addition

- (1) Press the ERROR ADDITION  [ON] key. (The lamp lights.)
- (2) Select the error addition rate by pressing [$<$] and [$>$] keys . For single error addition, on bit error is added each time [SINGLE] key is pressed.
- (3) Select the channel at which error is to be added with the rear panel ERROR ADDITION CH (1-32) switches X10 and X1 .

(The left switch (X10) sets the tens digits and the right switch (X1) sets the units digit.

01 to 32 can be set. When 00 is set, error is added at CH1 and when 33 to 99 is set, error is added at CH32.)

When the output pattern is divided into each bit as shown in Fig. 4-1, the bit at which error is to be added is selected with these switches X1 and X10.

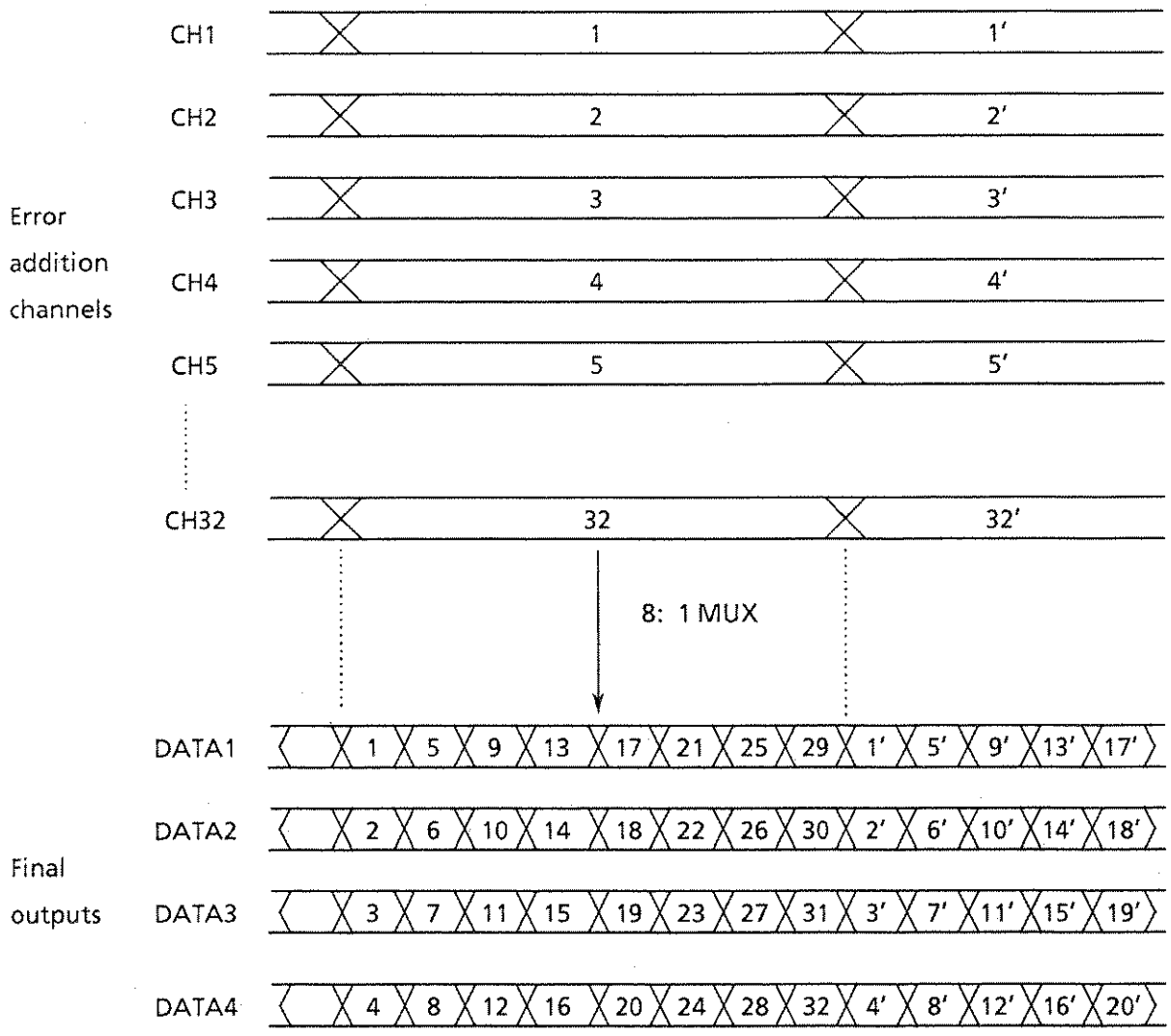

Note: Errors are added to the selected channels (1 to 32) only. As shown above, MUX processing is applied for the output data. (For example, if CH4 is selected, errors are periodically added to the positions 4 and 4' of the final output DATA4.)

Fig. 4-1 Error Addition Channel

4.7 Output Amplitude, Offset Voltage, and Delay Setting

(1) Data output

Press the TERM-GND/ECL key ⑩ while pressing the GUARD key to set the terminal voltage. Press the DISPLAY key ⑪ to turn on the lamp of the output or the external MUX unit to be set. Set the amplitude and offset voltage by turning the setting knobs of the DATA AMPLITUDE ⑬ and DATA OFFSET ⑭.

(2) Clock output

Press the TERM-GND/ECL key ⑩ while pressing the GUARD key to set the terminal voltage. Press the DISPLAY key ⑪ to turn on the lamp of the output or the external MUX unit to be set. Set the amplitude and offset voltage and the delays for the CLOCK1 and CLOCK2 by turning the setting knobs of the CLOCK AMPLITUDE ⑯, CLOCK OFFSET ⑰ and CLOCK DELAY ⑱.

(3) Offset reference value selector function

By selecting either of the V_{OH} , V_{TH} or V_{OL} by the offset reference value selector key ⑲, the reference value for the offset voltage of the DATA ⑭ and CLOCK ⑰ can be selected from the V_{OH} (high-level output), V_{TH} (intermediate value between high- and low-level outputs) and V_{OL} (low-level output).

When the amplitude is changed by changing the offset reference value, the output is as shown in Fig. 4-2.

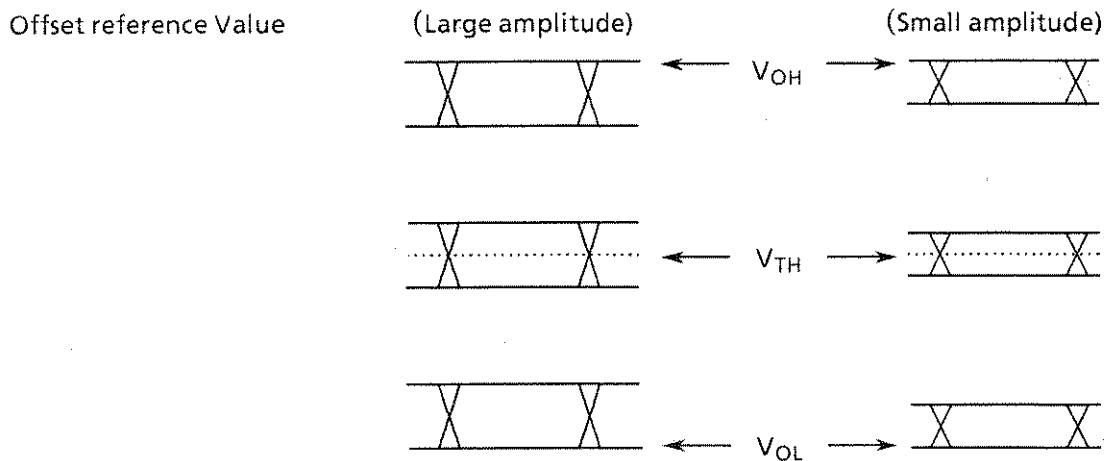

Fig. 4-2 Offset Reference Value and Amplitude Change

Note: Since the offset-voltage upper and lower limit values are limited by V_{OH} ($-2.0\text{ V} \leq V_{OH} \leq +2.0\text{ V}$), when V_{TH} or V_{OL} is set, the amplitude is limited at a certain value and may not change further.

Example:

If V_{OL} is set at $+1.00\text{ V}$ offset voltage and the signal amplitude is 0.5 V_{p-p} , the amplitude can only be increased to 1.0 V_{p-p} .

This is because their superposition after the increase would be meeting the maximum allowable level $+2.00\text{ V}$.

Figures 4-3 to 4-5 show the relationships between amplitude and offset-voltage settable ranges at three offset references.

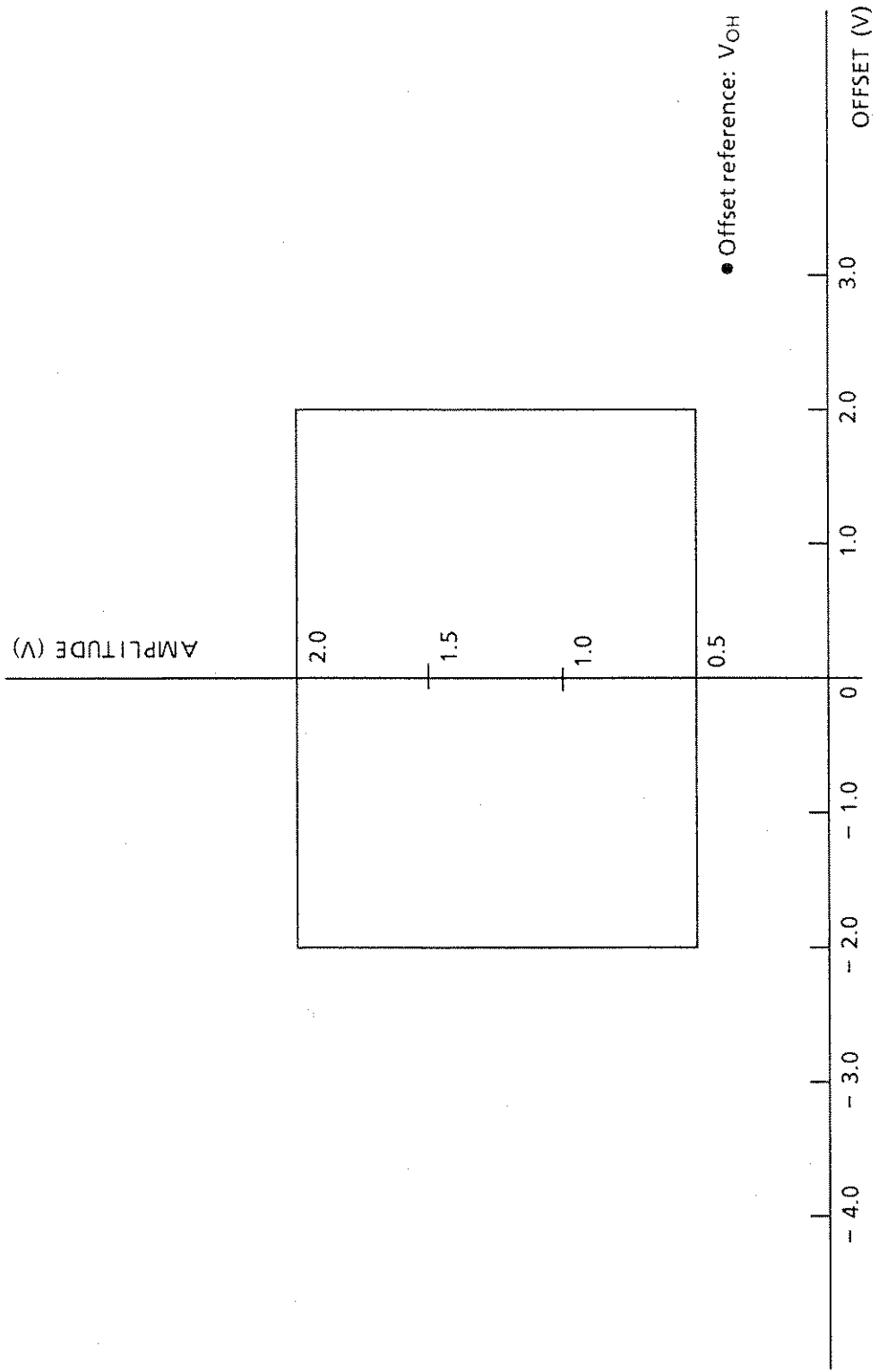

Fig. 4-3 Amplitude and Offset Voltage Setting Range Corresponding to Offset Reference Value

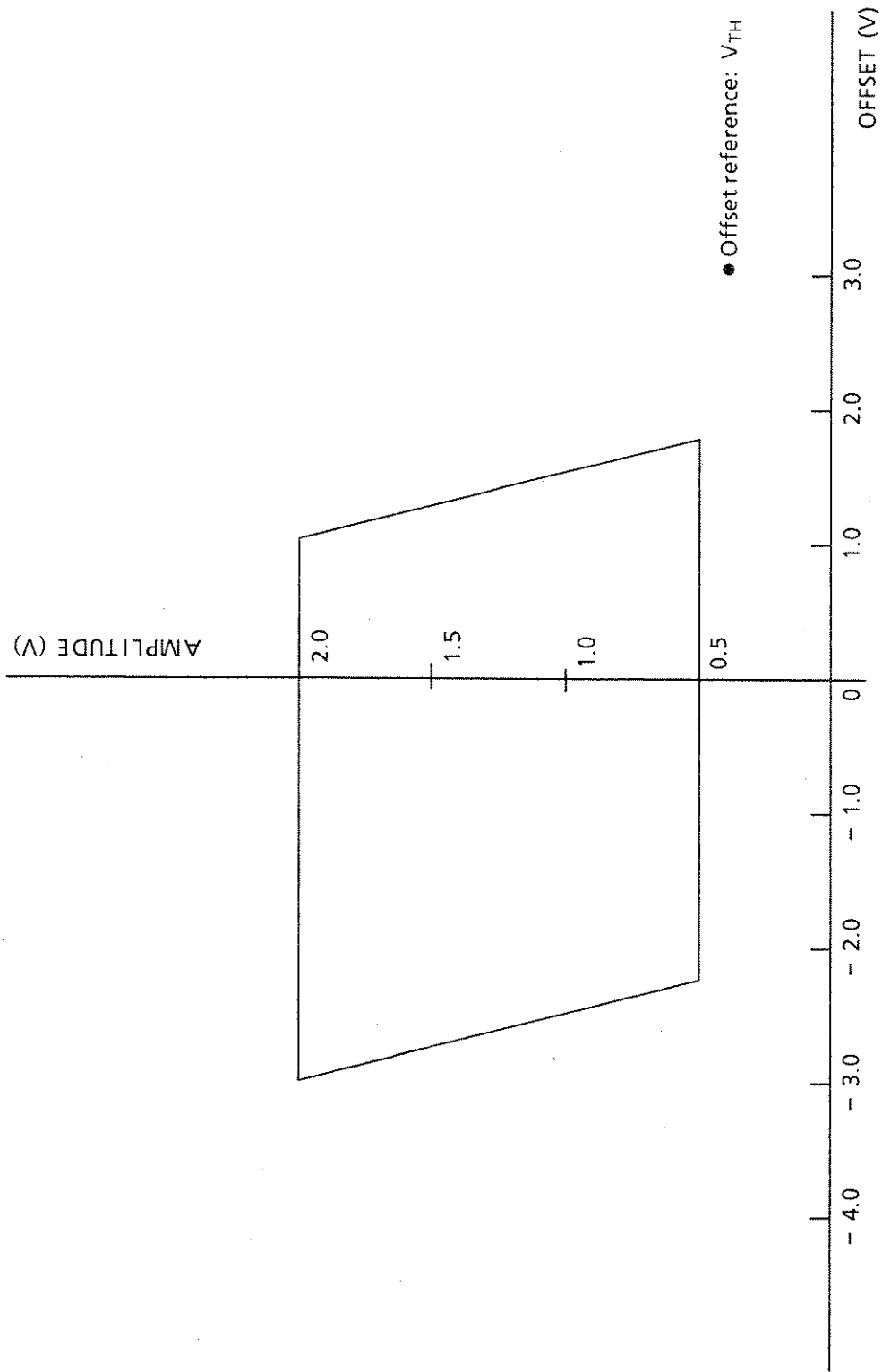

Fig. 4-4 Amplitude and Offset Voltage Setting Range Corresponding to Offset Reference Value

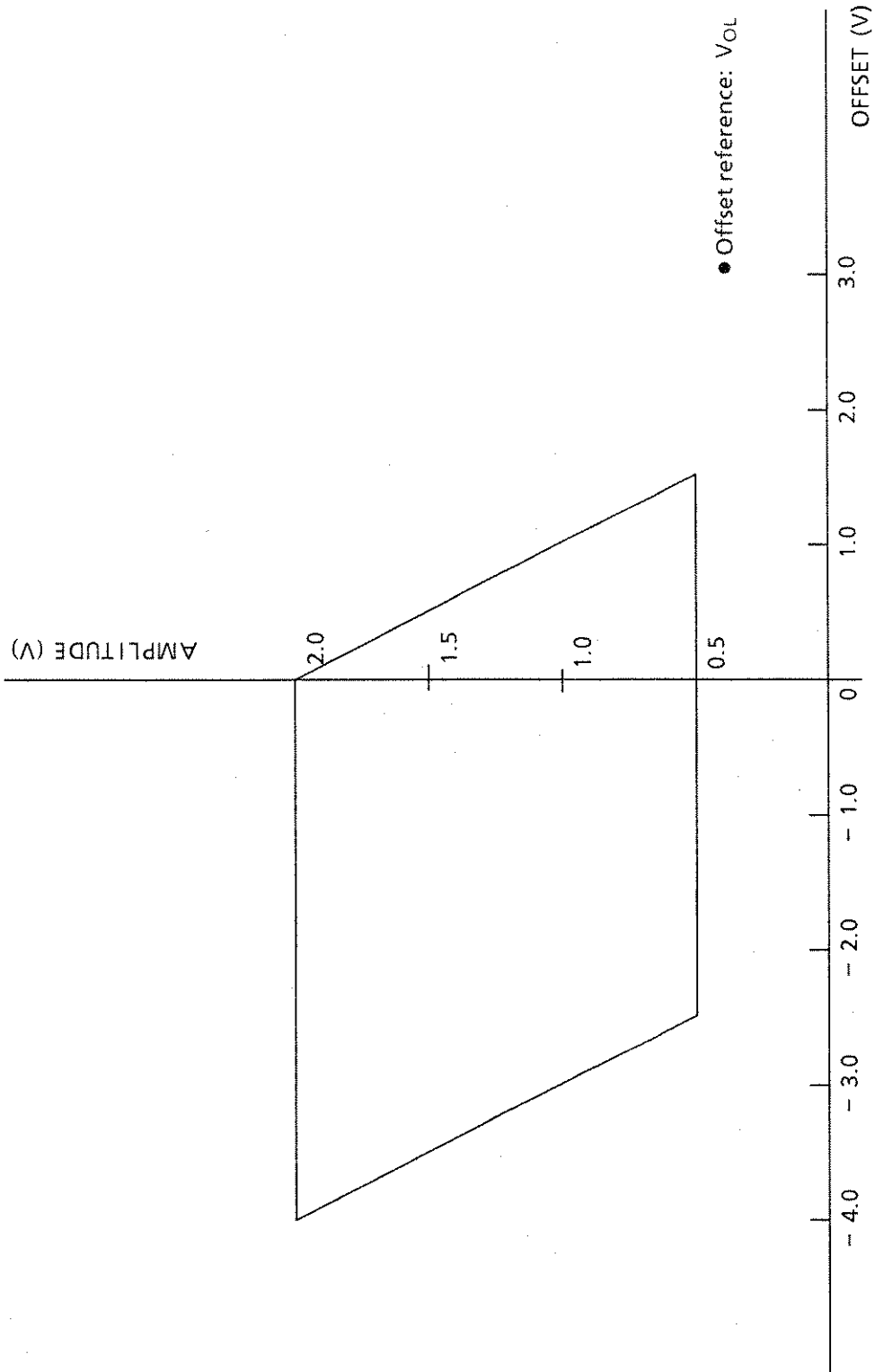

Fig. 4-5 Amplitude and Offset Voltage Setting Range Corresponding to Offset Reference Value

4.8 Memory

(1) Floppy disk insertion

Insert a formatted 3.5-inch 2HD-type floppy disk into the floppy disk drive ⑳. (The accessory floppy disk is formatted. For the formatting method, see paragraph 4.8 (8).)

(2) Mode setting

Set the PTN (pattern) mode or OTHERS mode by pressing MEMORY ㉑ [MODE PTN/OTHERS] key. In the PTN mode, the pattern set contents are stored; in the OTHERS mode, other set conditions (frequency, amplitude, offset voltage, etc.) are stored.

For each mode, file names from 00 to 99 can be selected.

(3) File save

Select the FILE No. display mode by pressing [DIR/FILE No.] key. Select the desired file name (00 to 99) by pressing [^] or [v] key and then press [SAVE] key.

In the PTN mode, the pattern set contents are saved; in the OTHERS mode, the other set conditions are saved.

(4) File recall

Select the PTN mode or OTHERS mode, and select the desired file name by pressing [^] or [v] key.

Press [RECALL] key to recall the contents of the file.

(5) Directory

Select the DIR mode with [DIR/FILE No.] key to access the floppy disk and check the saved file. Press [^] or [v] key to display only the names of the exist files on the inserted floppy disk. When there are no files on the inserted floppy disk, "--" is displayed.

In the DIR mode, recall, resave, and delete operations can be performed, but the save operation cannot be performed.

When returned to the FILE No. mode from the DIR mode, and if the file set with [^] or [v] key exists, the EXIST lamp lights.

Note: When the floppy disk is changed after the DIR mode is set, set the DIR mode again.

This is because the read directory information is stored in the MP1758A even if the floppy disk is removed, and the directory information will not match when a different floppy disk is inserted.

(6) File resave

After setting the shift mode by pressing [SHIFT] key, press [RESAVE] key to resave an existing file.

However, the resave operation may be impossible, depending on the free storage capacity of the floppy disk. Read the resave operation described in paragraph 4.8 (12).

(7) File delete

After setting the shift mode by pressing [SHIFT] key, press [DELETE] key to delete an existing file.

(8) Floppy disk formatting

Set the OTHERS mode and FILE No. mode, then press [^] key to display Fr (Fr follows 99).

After setting the shift mode by pressing [SHIFT] key, press [DELETE] key to format the floppy disk.

It takes about two minutes to format a floppy disk.

(9) Error message

When a floppy disk error occurs, error code E0 to E9 is displayed on the file name display.

The error messages are shown in Table 4-1.

All the keys in the MEMORY section, other than [v] and [^] keys, are disabled during error message display. To reset the error display, press [v] or [^] key once.

Table 4-1 Error Messages

Error code	Error contents
E0	Formatting or media error
E1	Write protection error
E2	File full (insufficient write area)
E3	Specified file not found at read
E4	File exists error (saving of same-name file is attempted)
E5	Write error
E6	Read error
E7	File type or file contents error
E8	FD error (other error)
E9	Hardware trouble error

(10) Memory capacity

Usually, 200 files can be stored on one floppy disk; 100 files in the OTHERS mode and 100 files in the PTN mode. However, when long data length and word length patterns are stored, the number of files that can be stored may decrease.

For example, when 512k bit patterns are stored in a 1.25 MB floppy disk, only 18 files can be stored (Paragraph 4.8 (11) (e)).

(11) Floppy disk

(a) Disk type

The floppy disk is formatted in standard MS-DOS format provided by the MS-DOS file handler. The formatted floppy disk becomes data disk type. This is because the MS-DOS handler does not copy the MS-DOS system.

The system disk containing the MS-DOS system can also be used to store data.

(b) Volume label

The volume label is provided when the floppy disk is formatted.

Volume label: MP1758A_DAT

This volume label is used to identify the floppy disk.

(c) File configuration

- Directory configuration

The directory configuration is composed of root directory only.

- File name, extension

The file name and extension have the format shown below.

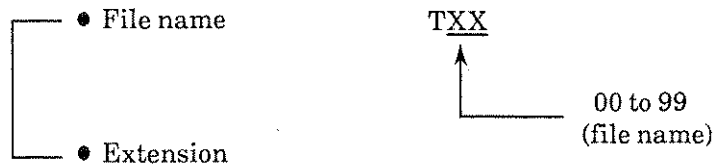

PTN: Pattern file

OTH: Parameter file for other than pattern

Examples: T99. PTN
T01. OTH

(d) Data format

Since the format of the data stored in floppy disk is not, as a rule, open to the user; operation is not guaranteed when data is generated, modified, etc. by using a personal computer that operates under MS-DOS.

However, file directory checking and file copying are of no problem.

(e) 512 k bits pattern data and floppy disk capacity

As mentioned previously in paragraph 4.8 (10), for 512 k bits pattern data, only 18 files can be stored.

The directory is shown below.

T99	PTN	65640	94-11-14	13 : 13
T98	PTN	65640	94-11-14	13 : 13
T97	PTN	65640	94-11-14	13 : 14
T96	PTN	65640	94-11-14	13 : 14
T95	PTN	65640	94-11-14	13 : 15
T94	PTN	65640	94-11-14	13 : 15
T93	PTN	65640	94-11-14	13 : 16
T92	PTN	65640	94-11-14	13 : 16
T91	PTN	65640	94-11-14	13 : 17
T90	PTN	65640	94-11-14	13 : 17
T89	PTN	65640	94-11-14	13 : 18
T88	PTN	65640	94-11-14	13 : 19
T87	PTN	65640	94-11-14	13 : 19
T86	PTN	65640	94-11-14	13 : 20
T85	PTN	65640	94-11-14	13 : 20
T84	PTN	65640	94-11-14	13 : 21
T83	PTN	65640	94-11-14	13 : 22
T82	PTN	65640	94-11-14	13 : 22

There are 18 files.

52224 bytes are available

Note: Refer to paragraph 4.8 (12).

(12) Resave operation

The resave function performed by the MP1758A is shown below.

When file named 01 is resaved, the following operation sequence is performed.

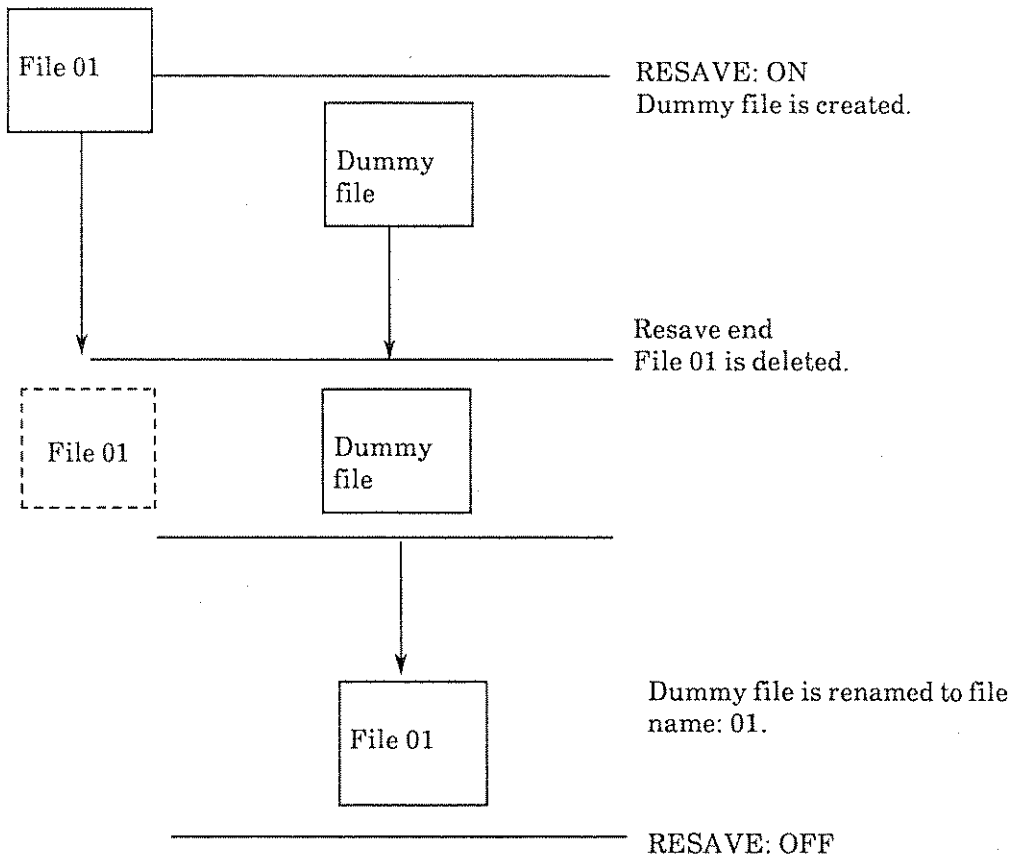

Resave cannot be performed by the operation above if the free space on the floppy disk is not equal to, or greater than, the size of the file to be resaved.

That is, for paragraph 4.8 (11) (e), since the free space on the floppy disk is only 52224 bytes, a 65 640-byte file cannot be resaved.

(13) Key operation during floppy disk accessing

While the floppy disk is accessed in the following operations,

- SAVE
- RESAVE
- RECALL
- DELETE
- FORMATTING
- DIRECTORY SEARCH

keys and knobs are almost in the same condition as panel lock and remain in the locked state up to the end of access.

(14) Notes on floppy-disk handling

Please pay careful attention to the following points.

- Do not remove the floppy disk from equipment being accessed.
- Observe the specified environmental conditions. Also, do not use the equipment in a dusty place.
- Keep magnetic objects away from the disk. Do not bend the disk.
- Files saved via the MP1758A Pulse Pattern Generator cannot be loaded into the MP1702A or any other instrument.

4.9 Parameters Initialization

When desiring to set the pattern type, amplitude, offset voltage, and other setting conditions to the initial factory-settings, turn on the POWER switch ① while pressing [LOCAL] key ②.

This initializes the settings. The initial state is shown in Table 4-2.

Table 4-2 Initial State

Item	Initial setting
CLOCK	INT
FREQUENCY	12500 MHz
TUNING	OFF
MEMORY	00 (PTN mode, FILE No. mode)
PATTERN	PRBS $2^{15} - 1$
LOGIC	POS
ERROR ADDITION	OFF
OFFSET	V_{OH}
DATA TERM	GND
DATA DISPLAY	1
DATA AMPLITUDE	1.0 V _{p-p}
DATA OFFSET	0 V
CLOCK TERM	GND
CLOCK DISPLAY	1
CLOCK AMPLITUDE	1.0 V _{p-p}
CLOCK OFFSET	0 V
CLOCK DELAY	0 ps

SECTION 5

PRINCIPLES OF OPERATION

5.1 Block Diagram

The MP1758A block diagram is shown in Fig. 5-1.

5.2 Internal Clock Generator (A1)

The clock generator is a synthesized clock generator consisting of PLL circuits with a 10 MHz crystal oscillator as the reference signal.

5.3 Programmable Pattern Generator (A8/A12)

The programmable pattern setting data is stored in RAM. The RAM has 128 k bits for each of output, and operates as 64 bit parallel. These data are sequentially multiplexed and finally form a single serial data. The pattern sequence is shown in Fig. 5-2.

5.4 Pseudorandom Pattern Generator (A10)

An LSI for PRBS generates 8 bit parallel data for each output. These data are sequentially multiplexed and finally form a single serial data.

The PRBS pattern generation principle is shown in Table 5-1.

Generally, a PRBS pattern with a period of 2^N-1 bits has one N-bit continuous "1" pattern per period.

When the LOGIC is set to POS (positive logic), a data output "1" corresponds to the low-level, and "0" to the high-level.

The pattern sequence is as shown in Fig. 5-3.

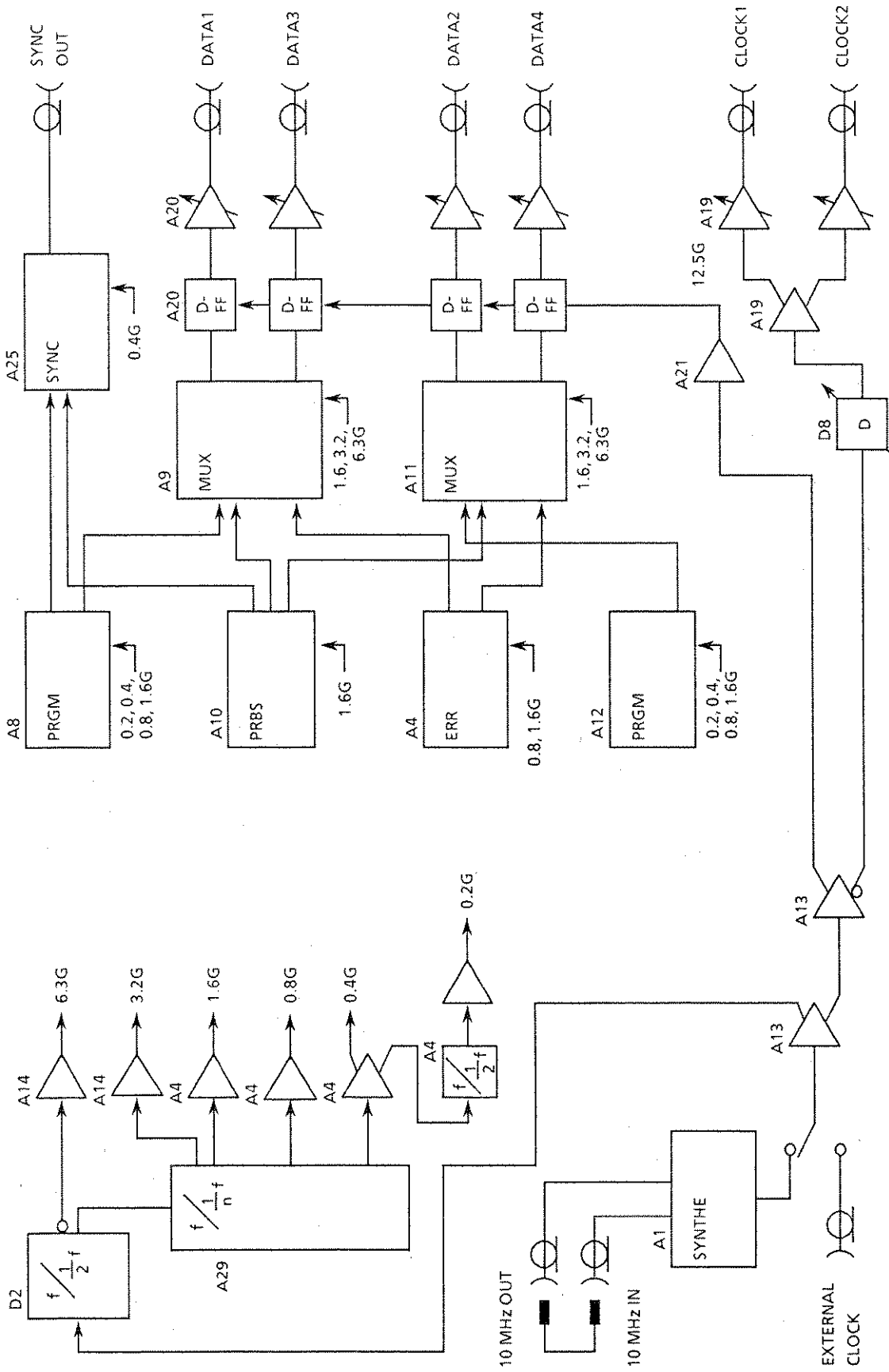
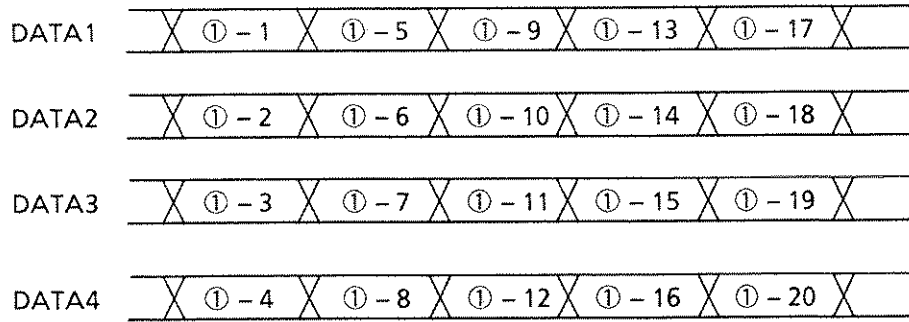
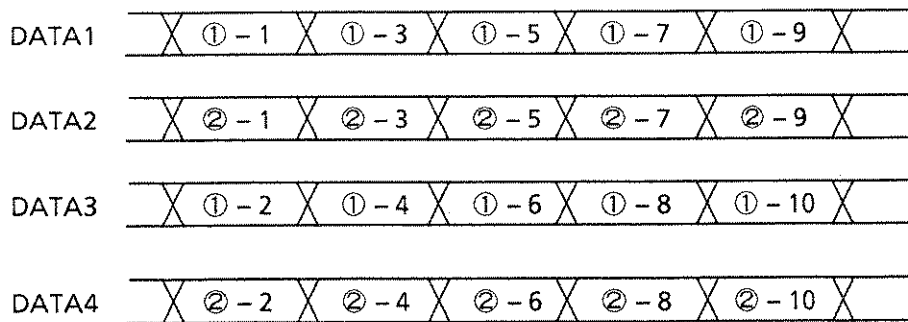

Fig. 5-1 MP1758A Block Diagram



(i) 1 CH mode

Each output sends a 1/4 demultiplexed pattern.



(ii) 2 CH mode

Each output sends a 1/2 demultiplexed pattern.

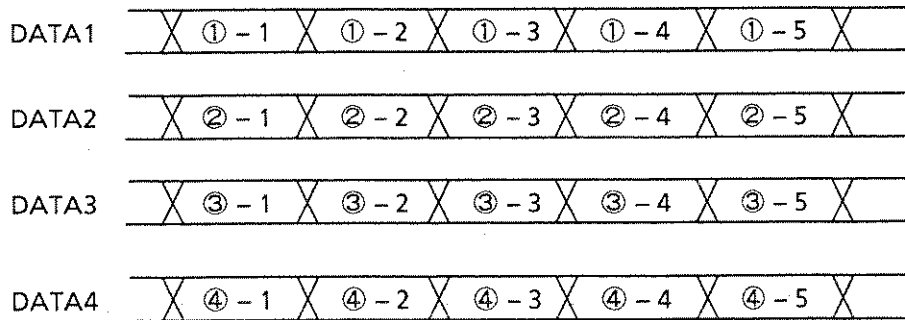

(iii) 4 CH mode

Each output independently sends the pattern.

①, ②, ③ and ④ above indicate data channels.

Fig. 5-2 Pattern Sequence in Programmable Pattern

Table 5-1 Pseudorandom Pattern Generation Principle

Period	Generation polynomial	Pattern generation block diagram
$2^7 - 1$	$1 + X^6 + X^7$	
$2^9 - 1$	$1 + X^5 + X^9$	
$2^{11} - 1$	$1 + X^9 + X^{11}$	
$2^{15} - 1$	$1 + X^{14} + X^{15}$	
$2^{20} - 1$	$1 + X^3 + X^{20}$	
$2^{23} - 1$	$1 + X^{18} + X^{23}$	
$2^{31} - 1$	$1 + X^{28} + X^{31}$	

\boxed{N} : Shift register

\oplus : Exclusive-or

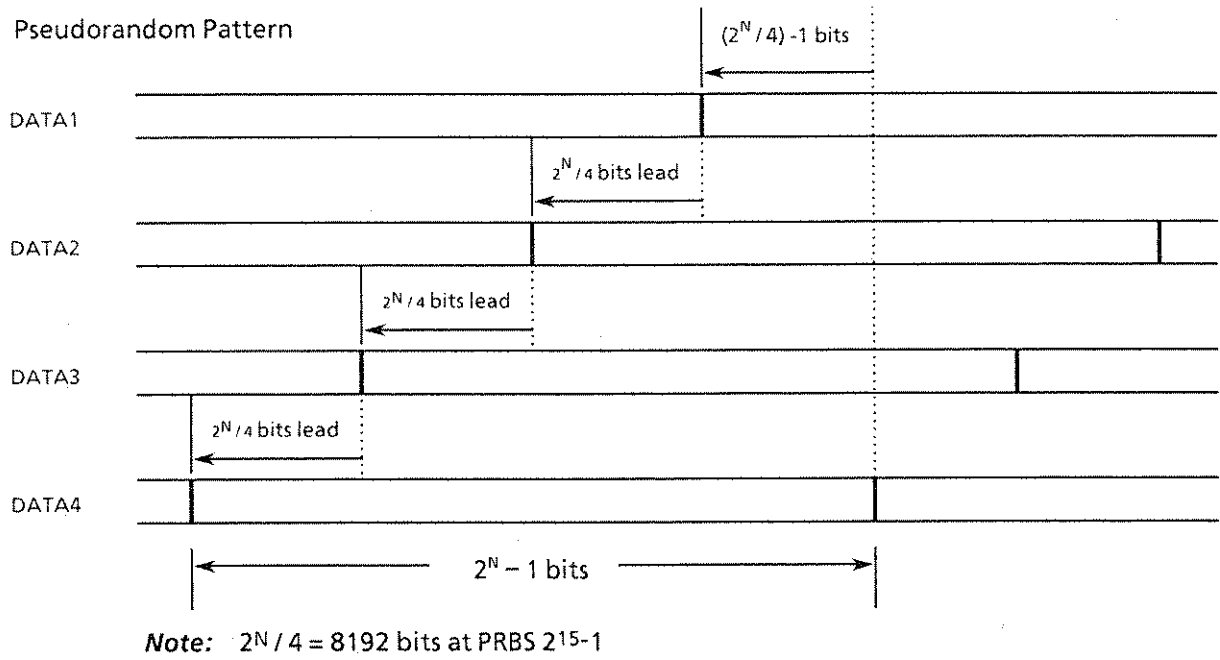

Fig. 5-3 Pseudorandom Pattern Sequence

5.5 Pattern Sync Output Period

5.5.1 Pseudorandom pattern

$$\text{Period} = [1/(\text{set frequency})] \times (2^N - 1) \times 16$$

$$N = 7, 9, 11, 15, 20, 23, 31$$

$$\text{Pulse width} = [1/(\text{set frequency})] \times 32$$

5.5.2 Programmable pattern

$$\text{Period} = [1/(\text{set frequency})] \times (\text{least common multiple between 64 and data length})$$

$$\text{Pulse width} = [1/(\text{set frequency})] \times 32$$

SECTION 6 MAINTENANCE

6.1 Regular Care and Preventive Maintenance

Table 6-1 lists the procedures and regularity with which regular maintenance should be performed.

Table 6-1 Regular Care and Maintenance

Period		Care and maintenance
Soiling	<ul style="list-style-type: none">● Before long-term storage● When duct has entered housing● When noticeable dust and dirt have accumulated inside cabinet	Wipe off dust with soapy water or cleaning solvent* Ensure that proper ventilation is provided
Dust and dirt		Open housing and blow out dust with compressed air; Take care to shield from dust or loose particles
Loose screws	When found	Retighten with screwdriver

* Do not use thinner or benzene since they will damage the coating.

(Blank)

SECTION 7 CALIBRATION

The calibration of the MP1758A can be performed only by Anritsu Corporation.

We recommend that the periodic calibration is performed. Please contact Service Department of Anritsu Corporation.

(Blank)